

TNC Style Connector

TNC Series

DDK Ltd.

FEATURE

- TNC series is a thread coupling coaxial connector which is modified BNC style connector.
- Due to the thread coupling, it is superior to BNC style connector in vibration load.
- Other electrical and mechanical characteristics are same as BNC style connector.
- Recommended torque of coupling is 45 ~ 68.6N · cm.



Characteristic Impedance

50 Ω

Frequency Range

DC to 2GHz

Lock Type

Screw

CONFORMING STANDARD

MIL-PRF-39012

SPECIFICATIONS

Characteristic Impedance	50 Ω
Rated Voltage	500VAC(r.m.s.)
Dielectric Withstanding Voltage	500V AC(r.m.s.) / 1 minute
Insulation Resistance	1,000M Ω min. at 500V DC
Contact Resistance	3m Ω max.
V.S.W.R.	1.3 max. (DC ~ 2GHz)
Operating Temperature	-55 ~ +85°C

* The specifications are typical but may not apply to all connectors. Please check the specifications on each item with its drawing from us when you use.

MATERIAL/FINISH



Item	Material / Finish
Shell	Copper Alloy / Ni or Ag Plating
Contact (Female)	Copper Alloy / Ag or Au Plating
Contact (Male)	Copper Alloy /Ag or Au Plating
Insulator	PTFE
Gasket	Silicon Rubber

© Please acknowledge that the specification etc. of this catalog might change by the improvement etc. without notice. Moreover, the characteristic and the specification of the published product are the reference values. Please confirm the content with the latest delivery specifications when you use the product.

▶ Straight Cable Plug

Clamp Type

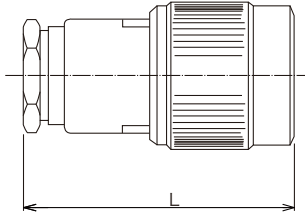

Part Number	Applicable Cable	L	Finish		Assembly Instruction
			Outer Conductor	Center Conductor	
TNC-P-3-CF	3D-2V	25.0	Ag	Ag	6
	3D-QEV				

Crimp Type

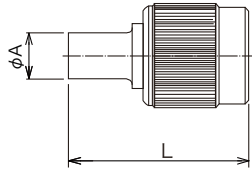

Part Number	Applicable Cable	φ A	L	Finish		Assembly Instruction	Crimp Tool
				Outer Conductor	Center Conductor		
TNC-P-1.5DQEW-CF	1.5D-2W	5.5	22.3	Ni	Au	1	CR-H-1100
	1.5D-QEW						
TNC-P-2.5D2W-CR10-CF	2.5D-2W	6.3	24.3	Ni	Ag	2	CR-H-1115
	2.5D-QEW						
TNC-P-3D2W-CR10-CF	3D-2W	7.9	24.3	Ni	Ag	2	CR-H-1135
	3D-QEW						

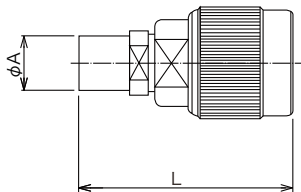

Part Number	Applicable Cable	φ A	L	Finish		Assembly Instruction	Crimp Tool
				Outer Conductor	Center Conductor		
TNC-P-2DFB-1-CF	2D-FB	6.2	29.7	Ni	Au	3	CR-H-1105

▶ Straight Cable Jack

Crimp Type

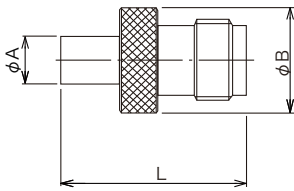

Part Number	Applicable Cable	φ A	φ B	L	Finish		Assembly Instruction	Crimp Tool
					Outer Conductor	Center Conductor		
TNC-J-1.5DXW-CR10-120-CF	2D-FB	5.5	12.0	26.8	Ni	Ag	4	CR-H-1142
TNC-J-2.5D2W-CR10-CF	2.5D-2W	6.25	14.6	25.0	Ni	Ag	4	CR-H-1105
	2.5D-QEW							

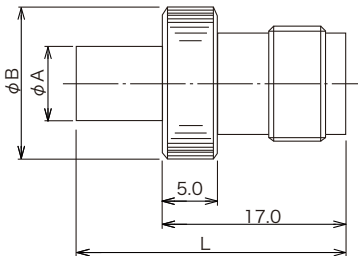

Part Number	Applicable Cable	φ A	φ B	L	Finish		Assembly Instruction	Crimp Tool
					Outer Conductor	Center Conductor		
TNC-J-3D2W-CR10-CF	3D-2W	7.9	14.6	25.42	Ni	Ag	4	CR-H-1135
	3D-QEW							

▶ Straight Bulkhead Cable Jack

Part Number	Applicable Cable	φ A	φ B	L	Finish		Assembly Instruction	Crimp Tool
					Outer Conductor	Center Conductor		
TNC-BJ-2.5D-QEW-CF	2.5D-2W	14.0	6.25	27.9	Ni	Ag	4	CR-H-1105
	2.5D-QEW							

※ Mounting Panel Thickness : 2.7mm max.

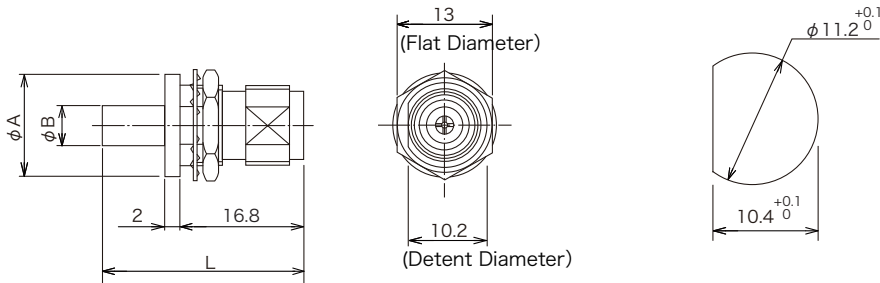

Panel Mounting Dimensions

© Please acknowledge that the specification etc. of this catalog might change by the improvement etc. without notice.
 Moreover, the characteristic and the specification of the published product are the reference values.
 Please confirm the content with the latest delivery specifications when you use the product.

► Straight Panel Cable Jack

Crimp Type

Part Number	Applicable Cable	Finish		Assembly Instruction	Crimp Tool
		Outer Conductor	Center Conductor		
TNC-PJ-1.5DQEW-CR10-CF	1.5D-QEW	Ni	Ag	5	CR-H-1142
	1.5D-2W				

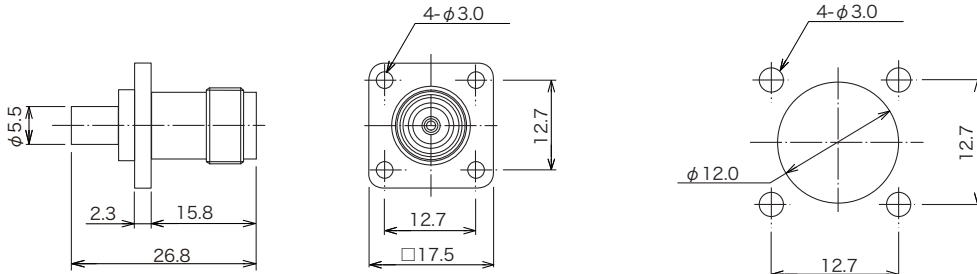

Panel Mounting Dimensions

Part Number	Applicable Cable	Finish		Assembly Instruction	Crimp Tool
		Outer Conductor	Center Conductor		
TNC-PJ-1.5DXW-CR10-M-CF	1.5D-XW	Ni	Ag	7	CR-H-1100
	1.5D-XWTA				

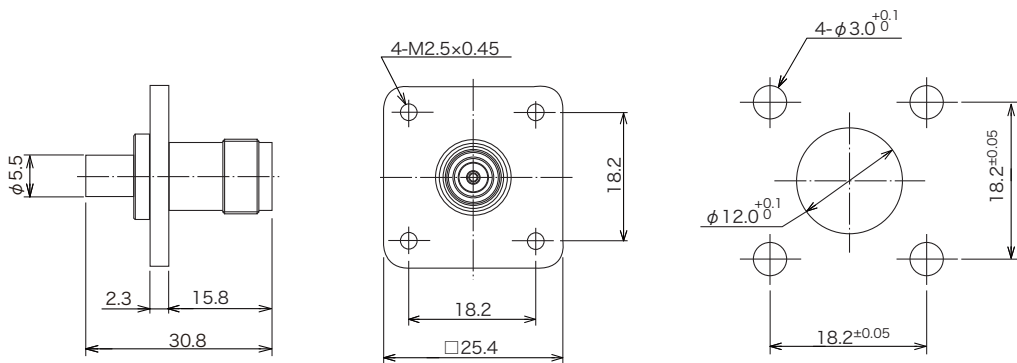

Panel Mounting Dimensions

Part Number	Applicable Cable	Finish		Assembly Instruction	Crimp Tool
		Outer Conductor	Center Conductor		
TNC-PJ-2H-1.5D-CR10-CF	1.5D-QEV	Ni	Ag	5	CR-H-1101
	1.5D-2V				

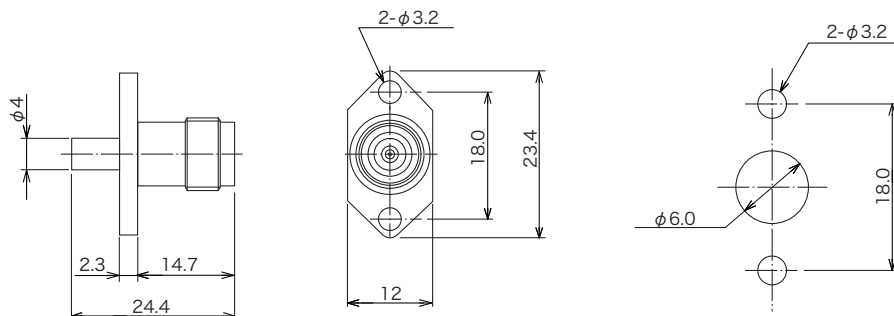

Panel Mounting Dimensions

© Please acknowledge that the specification etc. of this catalog might change by the improvement etc. without notice.
 Moreover, the characteristic and the specification of the published product are the reference values.
 Please confirm the content with the latest delivery specifications when you use the product.

▶ Receptacle Jack

Part Number	Finish	
	Outer Conductor	Center Conductor
TNC-R-CF	Ag	Au
TNC-R-NiCAu-CF	Ni	Au

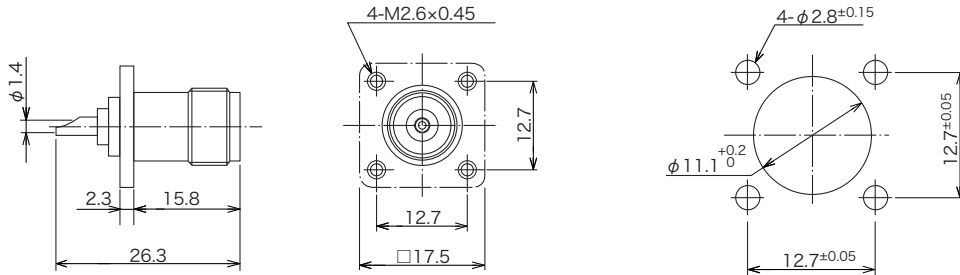

Panel Mounting Dimensions

Part Number	Finish	
	Outer Conductor	Center Conductor
TNC-R2-CF	Ag	Ag
TNC-R2-Ni-CF	Ni	Ag
TNC-R2-NiCAu-CF	Ni	Au

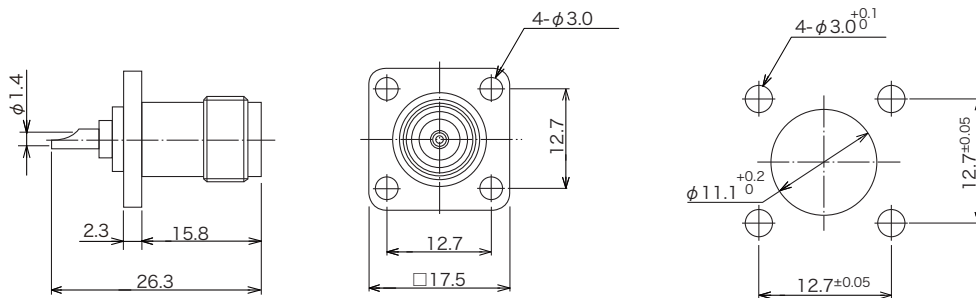

Panel Mounting Dimensions

Part Number	Finish	
	Outer Conductor	Center Conductor
TNC-R2-2H-Ni-CF	Ni	Ag

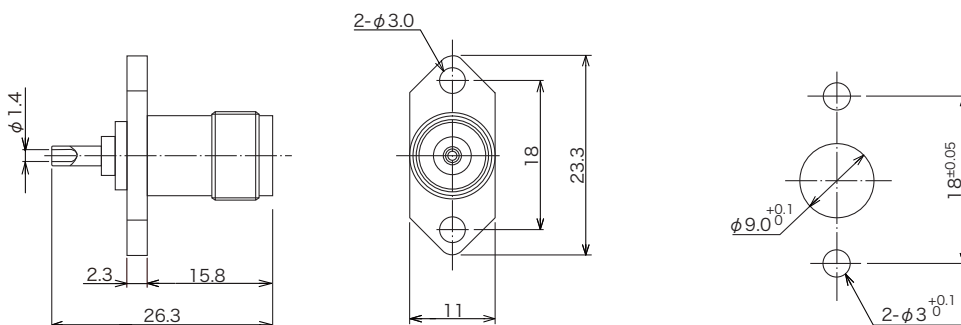

Panel Mounting Dimensions

© Please acknowledge that the specification etc. of this catalog might change by the improvement etc. without notice.
 Moreover, the characteristic and the specification of the published product are the reference values.
 Please confirm the content with the latest delivery specifications when you use the product.

▶ Receptacle Jack

Part Number	Finish	
	Outer Conductor	Center Conductor
TNC-SR-3-CF	Ni	Au

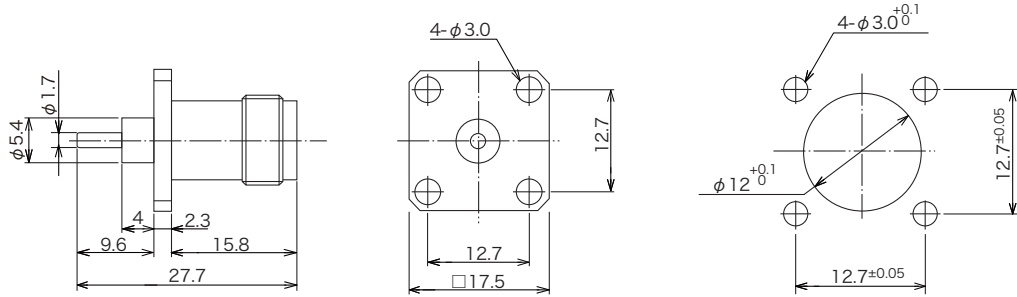

Panel Mounting Dimensions

Part Number	Finish	
	Outer Conductor	Center Conductor
TNC-SR-6-CF	Ni	Au

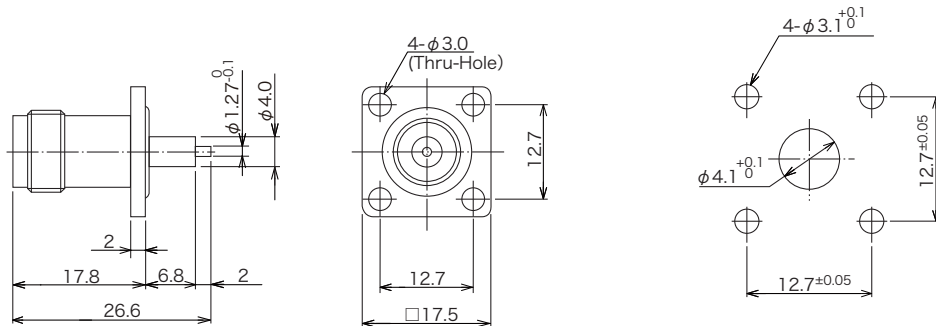

Panel Mounting Dimensions

Part Number	Finish	
	Outer Conductor	Center Conductor
TNC-SR-9-CF	Ni	Au

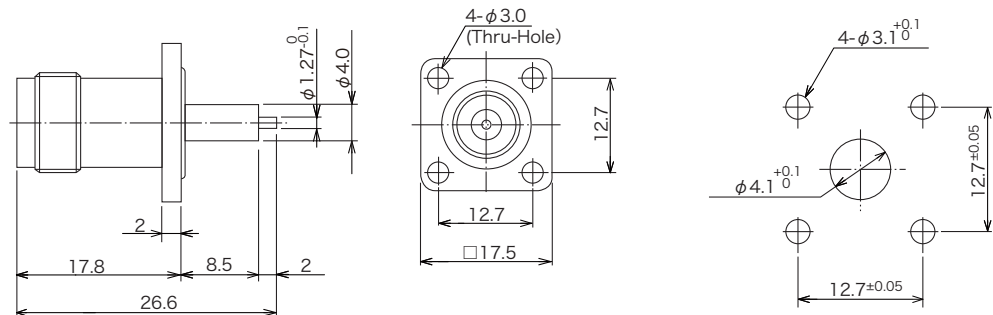

Panel Mounting Dimensions

© Please acknowledge that the specification etc. of this catalog might change by the improvement etc. without notice.
 Moreover, the characteristic and the specification of the published product are the reference values.
 Please confirm the content with the latest delivery specifications when you use the product.

▶ Receptacle Plug

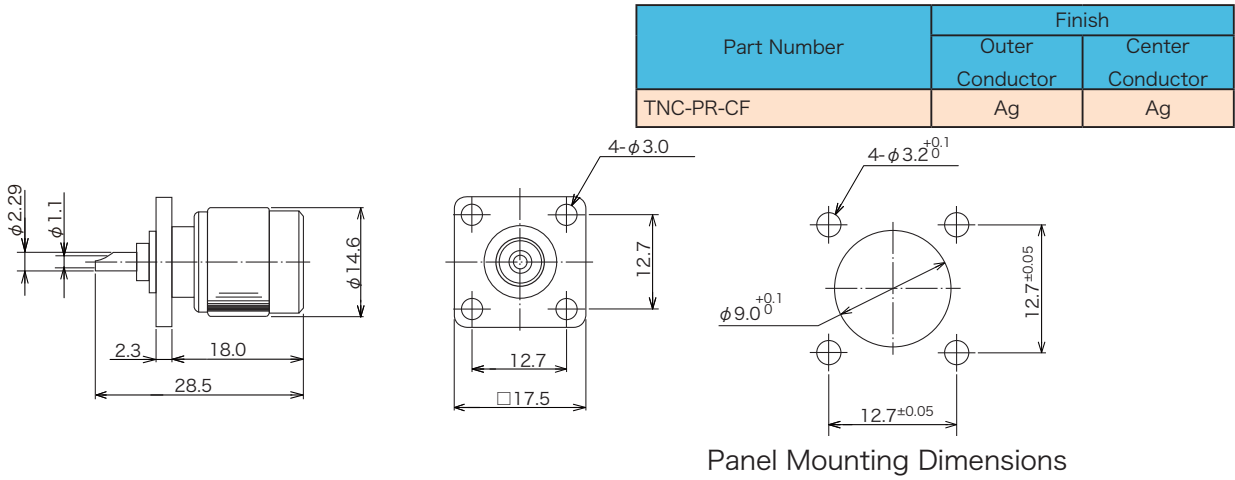

▶ Right Angle Receptacle Jack

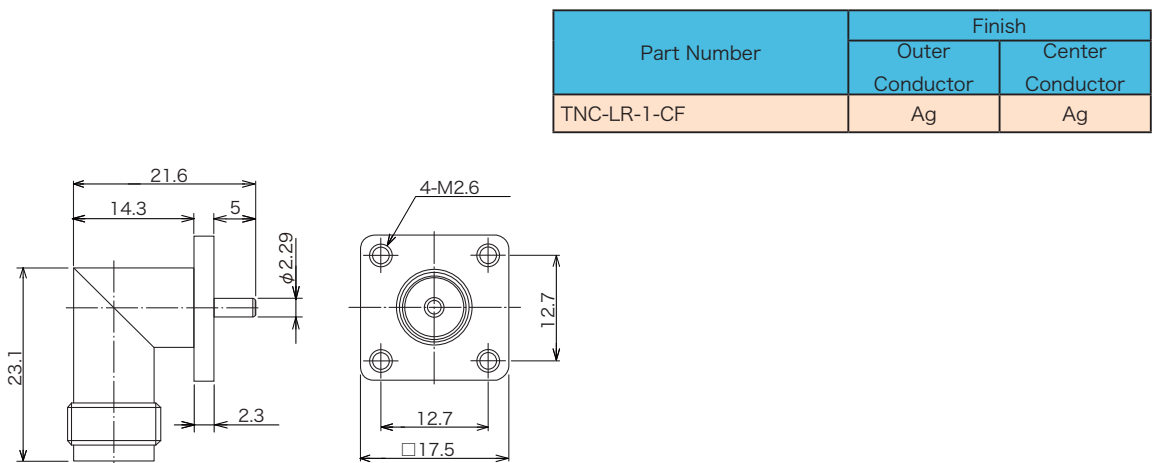
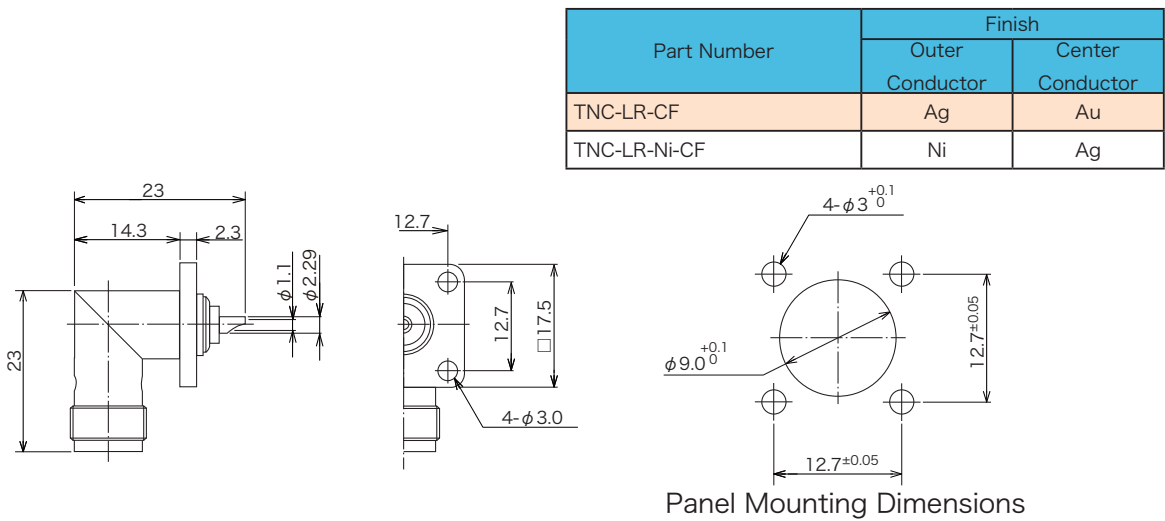

© Please acknowledge that the specification etc. of this catalog might change by the improvement etc. without notice.
 Moreover, the characteristic and the specification of the published product are the reference values.
 Please confirm the content with the latest delivery specifications when you use the product.

▶ Dust Cap

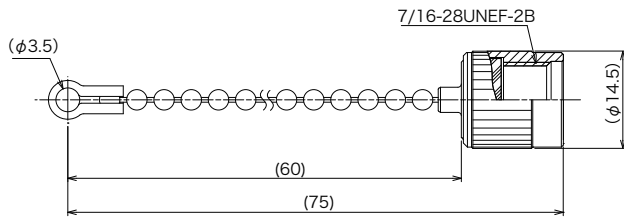

Part Number	Finish
TNC-RC-1	Ni
TNC-RC-1-D1	Ag

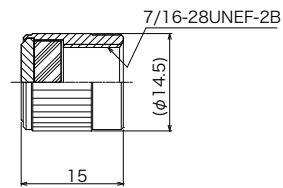

Part Number	Finish
TNC-C-2-CF	Ni
TNC-C-2-D1-CF	Ag

© Please acknowledge that the specification etc. of this catalog might change by the improvement etc. without notice.
 Moreover, the characteristic and the specification of the published product are the reference values.
 Please confirm the content with the latest delivery specifications when you use the product.

<http://www.ddknet.co.jp>

▶ Assembly Instruction (1)

Parts Configuration

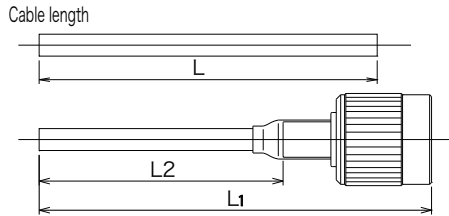
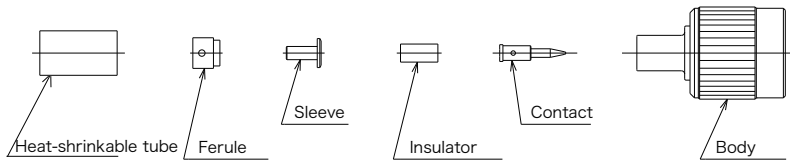

Cable length which require for the cable assembly.

$$L=L1-3.3$$

$$L=L2+19.7$$

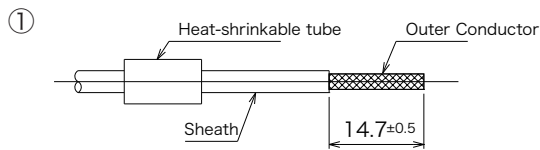

- ① Insert the heat-shrinkable tube onto the cable.
Cut the cable as fig.1.
Please be careful to not damage the outer conductor.

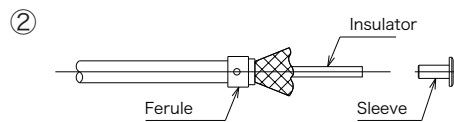

- ② Insert the ferule on the outer conductor and spread the top of the outer conductor.
Insert the sleeve between insulator and outer conductor. And cut the outer conductor along the sleeve.

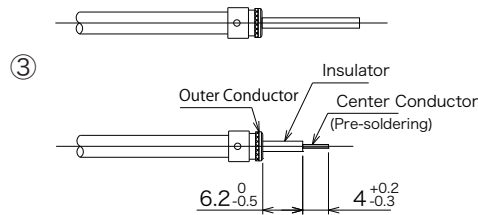

- ③ Cut the insulator as fig. 3.
Please be careful to not damage the center conductor.
Pre-solder the center conductor and cut the center conductor.
Please be careful to not damage the insulator by soldering. Insert the insulator as fig.3.

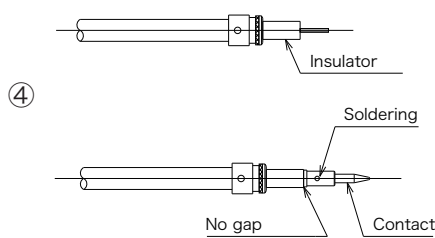

- ④ Solder up the contact with center conductor.
No gap between insulator and contact.

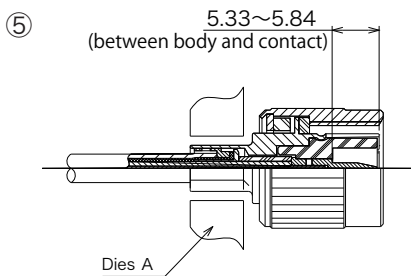

- ⑤ Insert the body into the above cable assembly.
And crimp the root of the body.
Please be careful to meet the crimp height as follows.

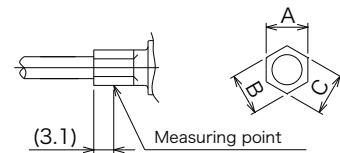

Note) Distance between body and contact must be met.

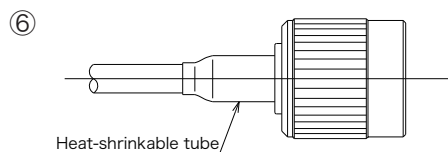

- ⑥ Cover the heat-shrinkable tube on the root of the body and heat up.

© Please acknowledge that the specification etc. of this catalog might change by the improvement etc. without notice.
Moreover, the characteristic and the specification of the published product are the reference values.
Please confirm the content with the latest delivery specifications when you use the product.

▶ Assembly Instruction (2)

Parts Configuration

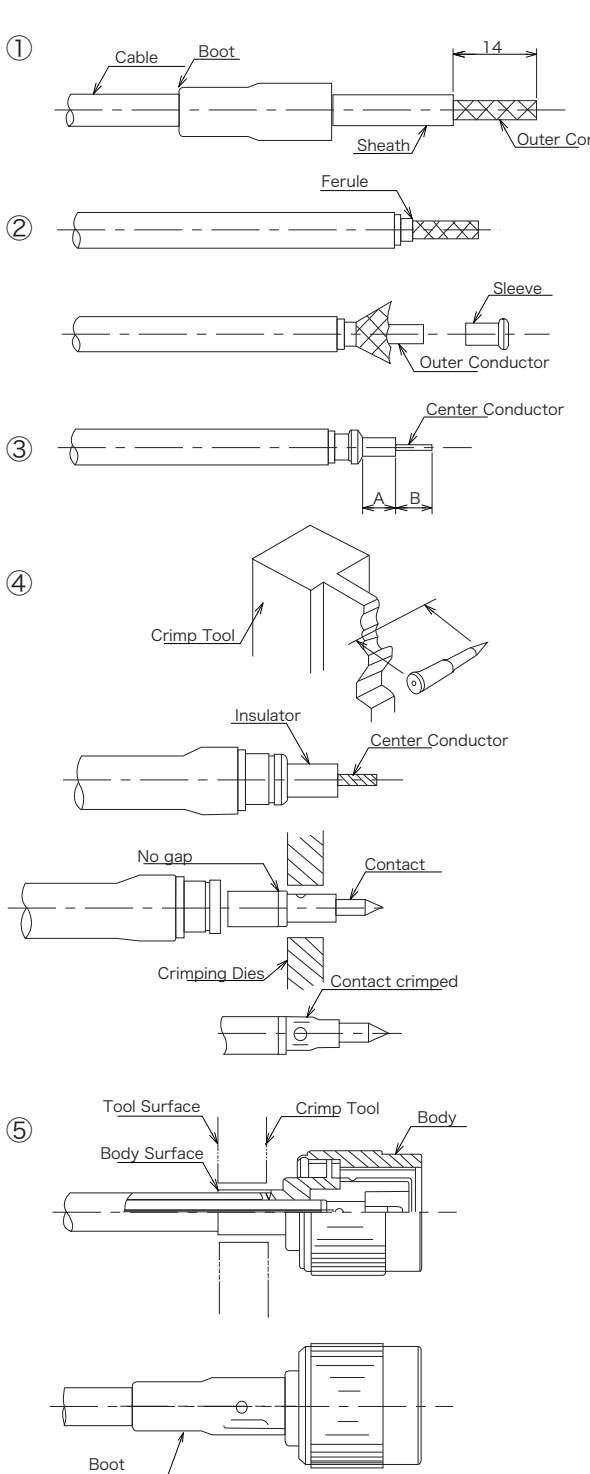
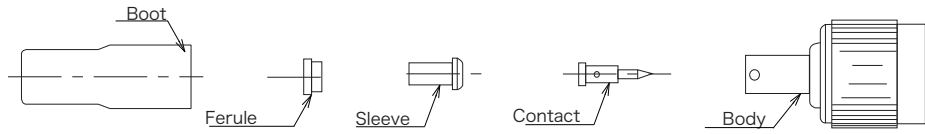

① Insert the boot into the cable and cut the cable as fig.1. Please be careful to not damage the outer conductor.

② Insert the ferule on the outer conductor and spread the top of the outer conductor. Press-in the sleeve between insulator and outer conductor. Cut the extra outer conductor along the sleeve.

③ Cut the insulator and center conductor as fig.3.

Part Number	A	B
TNC-P-2.5D2W-CR10-CF	5.0mm	4.0mm
TNC-P-3D2W-CR10-CF	5.5mm	3.5mm

④ Pinch the contact in the crimping hole(center hole) and insert the center conductor of the cable. Crimp the contact (match the side hole of contact with the curve of crimping hole of tool.)

Part Number	Crimp Tool
TNC-P-2.5D2W-CR10-CF	CR-H-1115
TNC-P-3D2W-CR10-CF	CR-H-1135

⑤ Insert the above contact into the body. Match the key in the insulator and keyway of the contact. Crimp the root of body as fig.5. Cover the boot on the root of the connector body.

© Please acknowledge that the specification etc. of this catalog might change by the improvement etc. without notice. Moreover, the characteristic and the specification of the published product are the reference values. Please confirm the content with the latest delivery specifications when you use the product.

▶ Assembly Instruction (3)

Parts Configuration

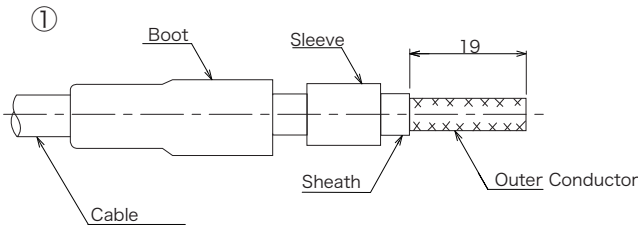
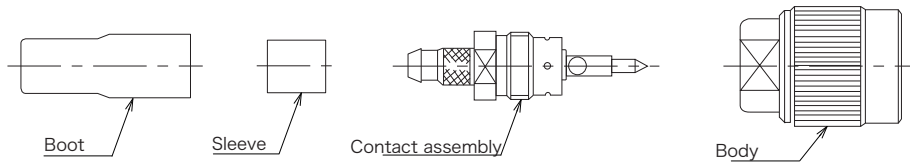

① Insert the boot and sleeve into the cable and cut the cable as fig.1. Please be careful to not damage the outer conductor.

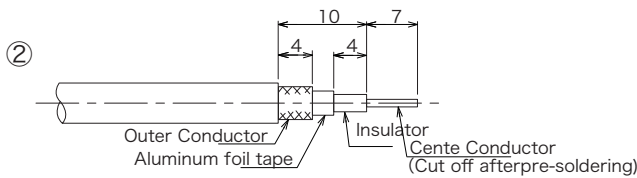

② Cut the cable as fig.2. Cut the center conductor after pre-soldering.

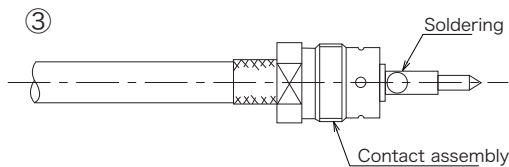

③ Insert the contact between outer conductor and aluminum foil tape. Solder the contact with center conductor. When the solder is stick out, please shave the extra solder along the contact.

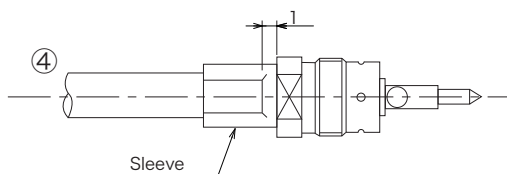

④ Cover the sleeve on the outer conductor and crimp as fig.4. Crimp Tool : (CR-H-1105)

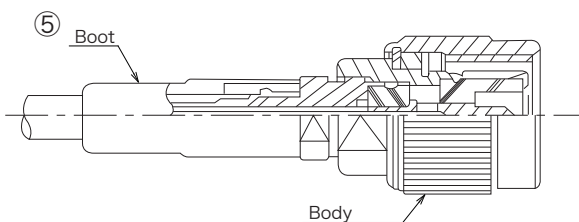

⑤ Insert the above contact into the body and screw. Cover the boot on the root of the body.

© Please acknowledge that the specification etc. of this catalog might change by the improvement etc. without notice. Moreover, the characteristic and the specification of the published product are the reference values. Please confirm the content with the latest delivery specifications when you use the product.

▶ Assembly Instruction (4)

Parts Configuration

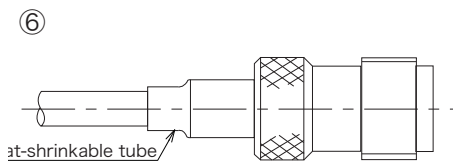
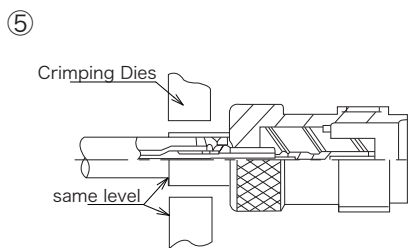
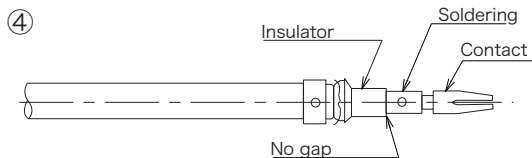
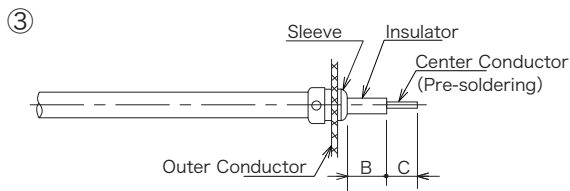
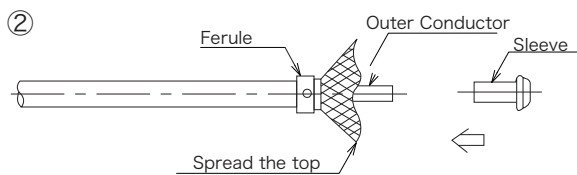
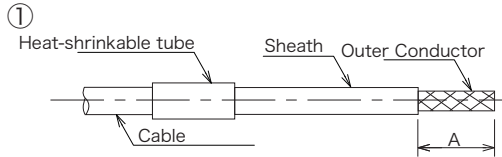
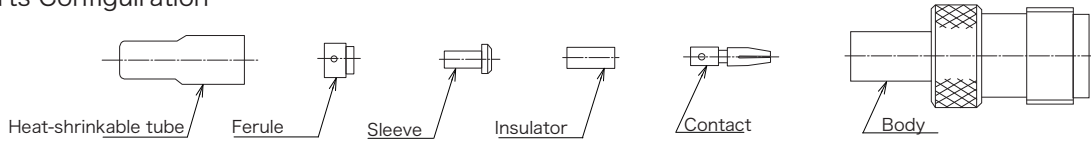

① Insert the heat-shrinkable tube into the cable and cut the cable as fig.1. Please be careful to not damage the outer conductor.

Part Number	A
TNC-J-1.5DXW-CR10-120-CF	13.0mm
TNC-J-2.5D2W-CR10-CF	11.0mm
TNC-J-3D2W-CR10-CF	11.5mm
TNC-BJ-2.5DQEW-CF	13.0mm

② Insert the ferule on the outer conductor and spread the top of the outer conductor. Press in the sleeve between outer conductor and insulator.

③ Cut off the extra outer conductor along the sleeve. Cut the cable as fig.3. Cut the center conductor after pre-soldering. Please be careful to not damage the center conductor.

Part Number	B	C
TNC-J-1.5DXW-CR10-120-CF	5.7mm	2.8mm
TNC-J-2.5D2W-CR10-CF	3.0mm	2.5mm
TNC-J-3D2W-CR10-CF	3.1mm	2.5mm
TNC-BJ-2.5DQEW-CF	6.0mm	2.0mm

④ Insert the insulator and solder the contact with center conductor. When the solder is stick out, please shave the extra solder along the contact.

⑤ Insert the above contact into the body. Match the key in the insulator and keyway of the contact. Crimp the root of body as fig.5.

Part Number	Tool
TNC-J-1.5DXW-CR10-120-CF	CR-H-1100
TNC-J-2.5D2W-CR10-CF	CR-H-1105
TNC-J-3D2W-CR10-CF	CR-H-1135
TNC-BJ-2.5DQEW-CF	CR-H-1105

⑥ Cover the heat-shrinkable tube on the root of the body and heat up.

© Please acknowledge that the specification etc. of this catalog might change by the improvement etc. without notice.
 Moreover, the characteristic and the specification of the published product are the reference values.
 Please confirm the content with the latest delivery specifications when you use the product.

▶ Assembly Instruction (5)

Parts Configuration

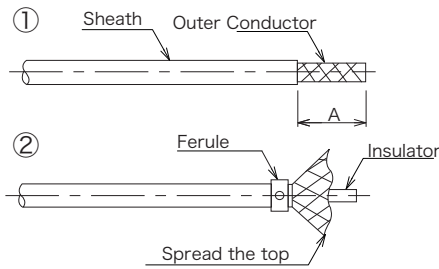
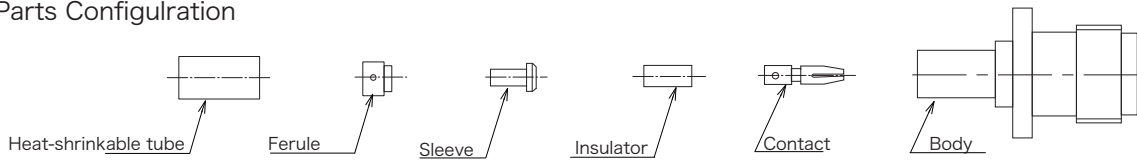

- ① Cut the cable as fig.1. Please be careful to not damage the outer conductor.

Part Number	A
TNC-PJ-1.5DQEW-CR10-CF	13.0mm
TNC-PJ-2H-1.5D-CR10-CF	10.0mm

- ② Insert the ferule on the outer conductor and spread the top of the outer conductor.

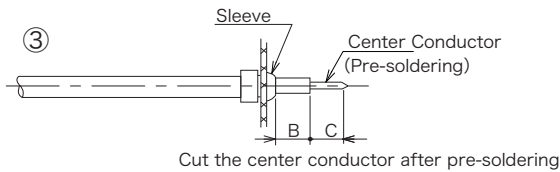

- ③ Insert the sleeve and cut the cable as fig.3. Press in the sleeve between outer conductor and insulator. Cut off the extra outer conductor along the sleeve. Cut the insulator and center conductor as below table. Cut the center conductor after pre-soldering. Please be careful to not damage the center conductor.

Part Number	B	C
TNC-PJ-1.5DQEW-CR10-CF	5.7mm	3.0mm
TNC-PJ-2H-1.5D-CR10-CF	4.0mm	3.0mm

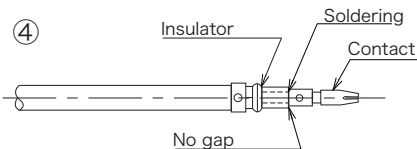

- ④ Insert the insulator on the insulator of the cable and solder the contact with center conductor. When the solder is stick out, please shave the extra solder along the contact.

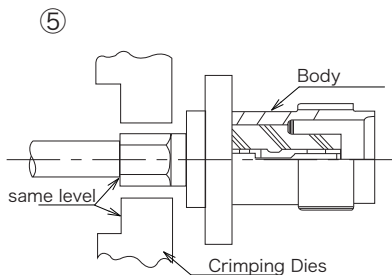

- ⑤ Insert the above contact into the body. Match the key in the insulator and keyway of the contact. Crimp the root of body as fig.5.

Part Number	Tool
TNC-PJ-1.5DQEW-CR10-CF	CR-H1142
TNC-PJ-2H-1.5D-CR10-CF	CR-H1101

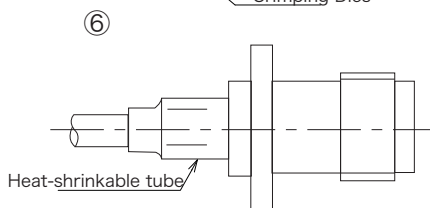

- ⑥ Cover the heat-shrinkable tube on the root of the body and heat up.

© Please acknowledge that the specification etc. of this catalog might change by the improvement etc. without notice. Moreover, the characteristic and the specification of the published product are the reference values. Please confirm the content with the latest delivery specifications when you use the product.

▶ Assembly Instruction (6)

Parts Configuration

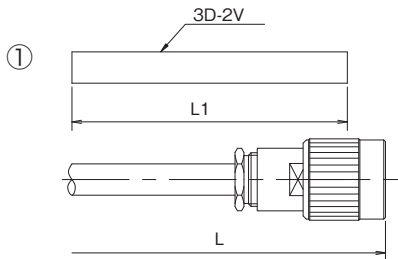
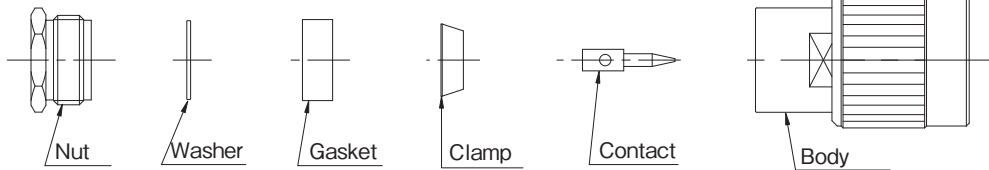

① The cable length require for the cable assembly $L1=L-x$

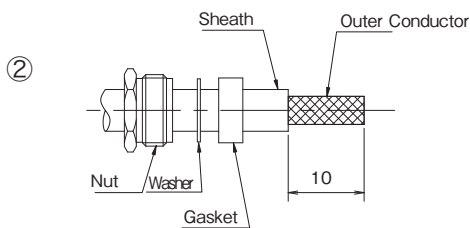

② Insert nut, washer and gasket into the cable and cut the cable as fig.2. Please be careful to not damage the outer conductor.

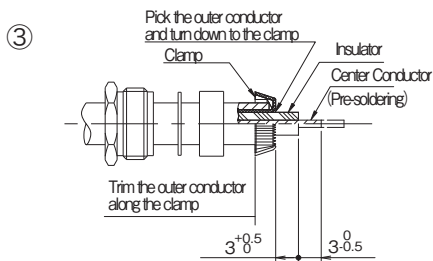

③ Insert the clamp on the outer conductor and turn down the outer conductor. Cut the outer conductor along the clamp. Cut the insulator as fig.3. Please be careful to not damage the center conductor. Cut the center conductor after pre-soldering.

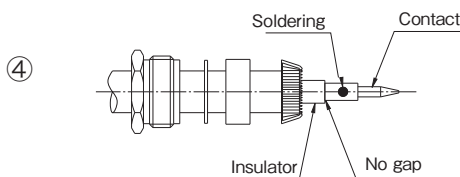

④ Insert the contact and solder the contact with center conductor. Please be careful to not damage the insulator by heat.

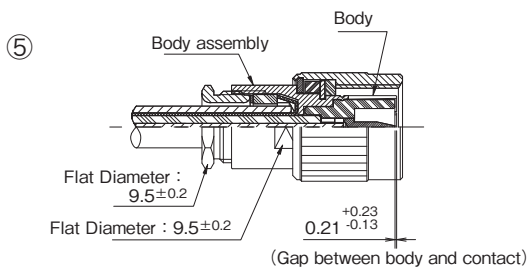

⑤ Insert the above contact into the body. Insert the the gasket and washer into the body and screw the nut.
Recommended torque : 117.5 ~ 147N · cm
(12 ~ 15Kgf · cm)

© Please acknowledge that the specification etc. of this catalog might change by the improvement etc. without notice.
Moreover, the characteristic and the specification of the published product are the reference values.
Please confirm the content with the latest delivery specifications when you use the product.

▶ Assembly Instruction (7)

Parts Configuration

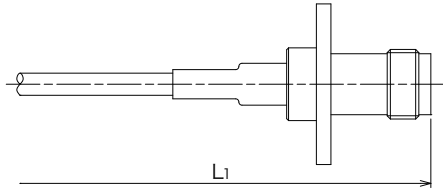
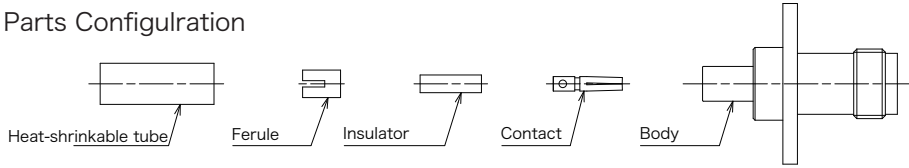

Cable length which require for the cable assembly.
 $L=L1-10.5$

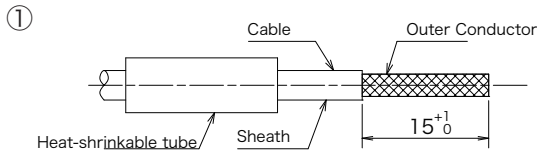

- ① Insert the heat-shrinkable tube into the cable.
 Cut the cable as fig.1.
 Note) Please be careful to not damage the outer conductor.

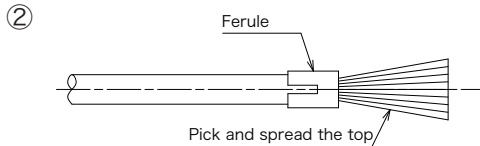

- ② Insert the ferule on the outer conductor
 Pick and spread the top.

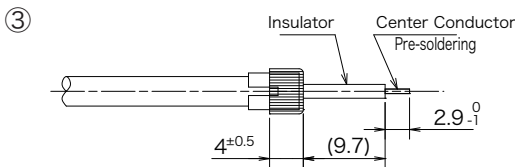

- ③ Turn down the outer conductor to the ferule and cut the outer conductor as fig.3.
 Cut the insulator as fig. 3 and pre-solder the center conductor. And cut the center conductor as fig.3.
 Note) Please be careful to not center conductor.

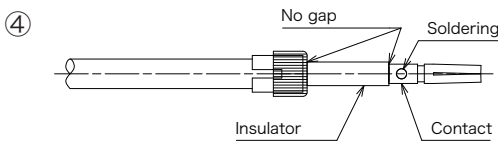

- ④ Insert the insulator into the cable, solder up the contact with center conductor.
 Note) When the solder is stick out, please shave the extra solder along the contact.

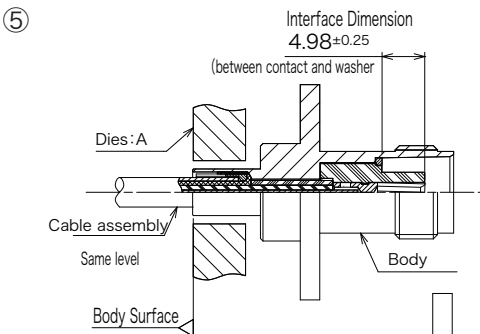

- ⑤ Insert the body into the above cable assembly and crimp the root of the body.
 Note) When inserting the body, match the contact notch with projection of insulator.
 Note) Crimp the body with same level of body and dies.
 Note) Meet the interface dimension and crimp height

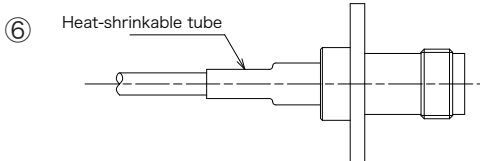
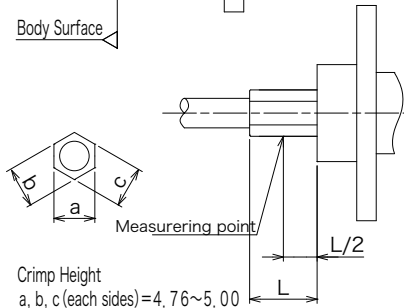

- ⑥ Cover the heat-shrinkable tube on the root of the body and heat up.

© Please acknowledge that the specification etc. of this catalog might change by the improvement etc. without notice.
 Moreover, the characteristic and the specification of the published product are the reference values.
 Please confirm the content with the latest delivery specifications when you use the product.